

# SKUM ZF Inductor

## Features

- Factory calibrated to any flow and pressure within the working range
- Standard suction height of 3.5 m – suction heights up to approximately 6 m available by request
- Standard foam induction rates available with SKUM AFFF 3% UG, SKUM ARC 3X3 UG, HOTFOAM 2% High-Expansion, or METEOR X 2% High-Expansion foam concentrates – other agents and induction rates available by request
- Can be installed in a horizontal or vertical plane between ANSI Class 150 or DIN PN16 flanges
- Grooved connection and check valve on foam concentrate inlet

## Application

The SKUM ZF Inductor injects foam concentrate into a water stream in a foam system with fixed flow rates. The inductor is designed to handle high back-pressures, extending the allowable distance from the point of foam injection to the point of foam application.

The Inductor can be calibrated for use with many types of foam concentrate, making it suitable for a variety of foam system applications. The inductor is designed to be installed between flanges with a suction line installed to draw foam from an atmospheric foam concentrate tank.

Typical applications include deluge systems with sprinklers or high-expansion generators such as those used in aircraft hangers or storage facilities.

## Description

The SKUM ZF Inductor consists of a bronze body, foam inlet, metering orifice, and recovery horn. The foam inlet has a grooved connection adapter and check valve installed by the manufacturer. The body is labeled to show flow direction and system information such as concentrate type, induction rate, flow rate, and pressure. The orifice is sized by the manufacturer for the specific flow and pressure in which the inductor will be installed.

Standard inductor installations may have suction heights of up to 3.5 m. Total concentrate piping must not exceed the maximum suction height as a combination of friction loss and elevation head loss from the lowest possible foam concentrate level that can be accessed by the suction line. For suction heights above 3.5 m, contact Technical Services.

The inductor is installed between two ANSI Class 150 or DIN PN16 flanges. A minimum amount of straight pipe is necessary upstream and downstream of the inductor. See Dimensions J and K under Inductor Dimensions for recommended minimum pipe lengths at each inductor size.



009902

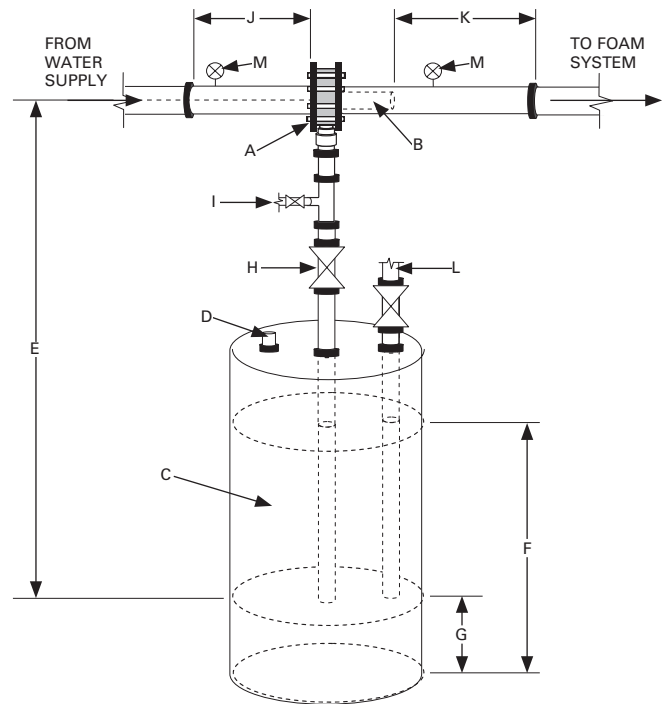

TYPICAL SKUM INDUCTOR SYSTEM

009903

**Note:** The above drawing is not to scale. For example purposes only.

- A. SKUM ZF Inductor with check valve installed between flanges
- B. Recovery horn in downstream piping
- C. Foam concentrate storage tank (atmospheric type)
- D. Pressure/vacuum vent
- E. Suction height (Maximum of 3.5 m for standard installations)
- F. Foam concentrate level in storage tank
- G. Inaccessible foam concentrate below suction line
- H. Concentrate shut-off valve
- I. Flushing line connection
- J. Minimum straight pipe upstream from the inductor
- K. Minimum straight pipe downstream from the inductor
- L. Fill connection
- M. Inlet and outlet pressure gauges

## Calculations

Each SKUM ZF Inductor is calibrated to the customer-specified system requirements (flow rate and pressure at inductor inlet, foam concentrate type, induction rate, etc.). This information must be provided when ordering.

The required flow of the inductor is dictated by the flow requirement of the discharge devices at the design pressure of the foam system. When determining the pressure for a SKUM ZF Inductor, two pressure drop calculations must be done:

- On the inductor outlet/system side: from the most remote discharge device to the inductor outlet
- On the inductor inlet/supply side: from the inductor inlet to the fire water supply pump

To help ensure reliable long term function of the system, it is recommended to add a safety margin to the calculation of the pressure loss from the discharge device to the inductor outlet. This accounts for an increase in pressure drop as the system ages. SKUM recommends using a roughness coefficient of no more than  $C=100$  when calculating the pressure losses of the piping system using the Hazen-Williams equation. Consult the Authority Having Jurisdiction (AHJ) as they may require a more conservative C value based on site conditions.

### EXAMPLE CALCULATIONS

Head Loss (Hazen-Williams) Formula:

$$P = \left( \frac{6.05 \times Q^{1.85}}{C^{1.85} \times d^{4.87}} \right) \times 10^5$$

Where:

- P = Friction loss (bar/m)
- Q = Flow rate (Lpm)
- d = Inside pipe measurement (mm)
- C = Pipe roughness coefficient

#### Example:

A high-expansion system with one discharge device requires 600 Lpm at 6.2 bar at the generator inlet with a 2% foam concentrate. The inductor will be connected to the generator with 30 m equivalent length of DN50 (2 in.) Schedule 40 pipe.

The head loss and pressure drop to the generator are:

$$Q = 600 \text{ Lpm}$$

$$d = 55.501 \text{ mm}$$

$$C = 100$$

$$P = \left( \frac{6.05 \times 600^{1.85}}{100^{1.85} \times 55.501^{4.87}} \right) \times 10^5 \approx \underline{0.053 \text{ bar/m}}$$

The pressure drop to the generator is:

$$0.053 \text{ bar/m} \times 30 \text{ m} \approx \underline{1.6 \text{ bar}}$$

The designer calculates a static head loss because of elevation changes of 0.7 bar. The total demand at the inductor outlet is:

$$6.2 \text{ bar} + 1.6 \text{ bar} + 0.7 \text{ bar} = \underline{8.5 \text{ bar}}$$

The maximum back-pressure at the inductor outlet is 65% of the inlet pressure. The demand at the inductor inlet is:

$$8.5 \text{ bar} \div 65\% = \underline{13 \text{ bar}}$$

The designer also calculates a pressure loss of 0.5 bar from the fire water pump to the inductor. The pressure requirement of the fire water supply is: 13 bar + 0.5 bar = 13.5 bar

- The fire pump must supply 600 Lpm at 13.5 bar
- A DN50 SKUM ZF Inductor should be ordered at 600 Lpm at 13 bar for use with 2% high-expansion foam concentrate

## Installation Requirements

1. The inductor is to be installed between flanges with the recovery horn inserted into the downstream piping.
2. Total concentrate piping must not exceed 3.5 m equivalent pipe as a combination of friction loss and elevation head loss from the lowest possible foam concentrate level that can be accessed by the suction line.
3. Downstream pipe, fittings, elevation head, and discharge devices must not result in inductor outlet backpressure in excess of 65% of inductor inlet pressure. Consult with the system designer to verify.
4. A minimum amount of straight pipe upstream and downstream of the inductor is recommended. See Dimensions J and K under Inductor Dimensions for recommended minimum pipe lengths.
5. A check valve must be installed in the foam concentrate line with the direction of flow from the foam concentrate storage tank to the inductor. The required check valve is installed on the SKUM ZF Inductor foam concentrate inlet by the manufacturer.
6. A T-fitting and additional valving on the concentrate line to allow flushing after discharge is recommended.
7. The ZF40, ZF50, ZF65, and ZF80 are designed to be installed between two DIN PN16 flanges. Larger units can be installed between two DIN PN16 or ANSI Class 150 flanges.
8. Piping to foam concentrate must not be smaller than the concentrate inlet connection. See Dimension B under Inductor Dimensions.

### NOTICE

Exceeding foam concentrate line limitations or using pipe sizes smaller than the foam concentrate inlet of the line proportioner, may reduce concentration percentages.

## Ordering Information

System requirements (inlet pressure, flow rate, lift height, concentrate name, and induction rate) must be provided at the time of order to properly manufacture the inductor. Standard units must be ordered within the suction height and working range limitations for use with SKUM AFFF 3% UG, SKUM ARC 3X3 UG, HOTFOAM 2% High-Expansion, or METEOR X 2% High-Expansion foam concentrates. Additional information or manufacturing time may be required for nonstandard installations.

Part No.	Approximate Shipping Weight
ZF40	3 kg
ZF50	4 kg
ZF65	7 kg
ZF80	9 kg
ZF100	11 kg
ZF150	21 kg
ZF200	40 kg
ZF200S	46 kg

# Inductor Dimensions

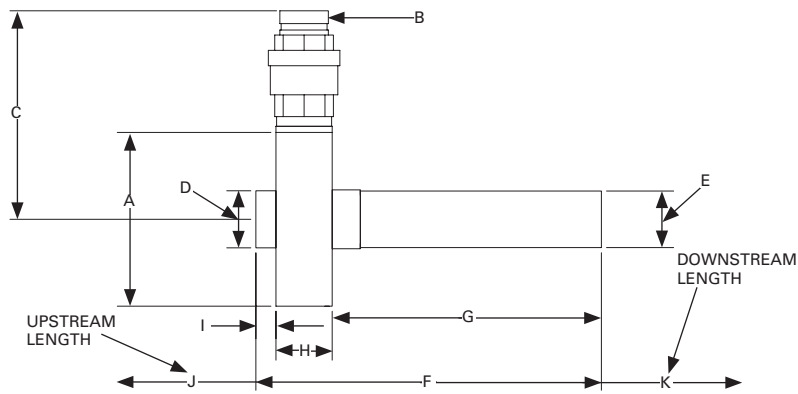

009916

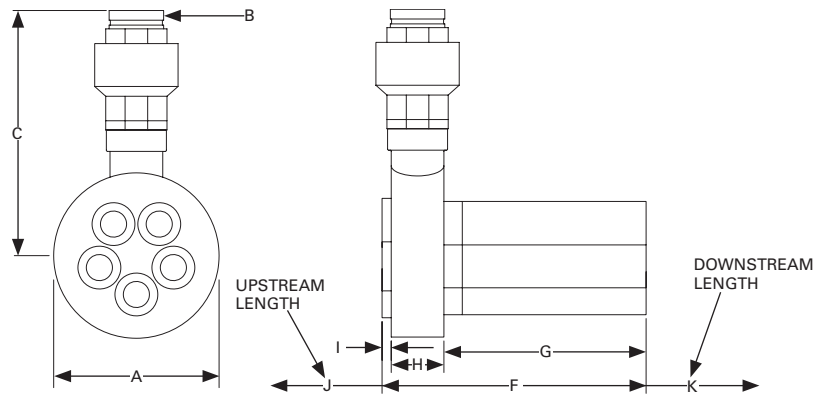

009917

**Note:** All dimensions are for reference only. Actual units may differ from the example drawings.

Part No.	Dimensions													
	A	B <sup>1</sup>	C	D	E	F	G	H <sup>2</sup>	I	J <sup>3</sup>	K <sup>4</sup>			
	mm	in.	(mm)	mm	mm	mm	mm	mm	mm	mm	x Dia	mm	x Dia	mm
ZF40	91.0	3/4	(19.1)	142.0	40.0	40.0	273.0	223.0	38.0	12.0	5 x Dia	200.0	6 x Dia	280.0
ZF50	105.0	3/4	(19.1)	149.0	40.0	40.0	273.0	223.0	38.0	12.0	5 x Dia	250.0	7 x Dia	300.0
ZF65	126.0	1	(25.4)	170.0	60.0	60.0	400.0	340.0	45.0	15.0	5 x Dia	325.0	5 x Dia	325.0
ZF80	142.0	1	(25.4)	190.0	60.0	60.0	413.0	340.0	58.0	15.0	5 x Dia	400.0	5 x Dia	400.0
ZF100	160.0	1 1/2	(38.1)	215.0	70.0	70.0	421.0	343.0	58.0	20.0	5 x Dia	500.0	5 x Dia	500.0
ZF150	215.0	2	(50.8)	258.0	70.6	70.0	430.0	335.0	70.0	25.0	5 x Dia	750.0	5 x Dia	750.0
ZF200	270.0	2 1/2	(63.5)	366.0	-	-	431.0	330.0	86.0	15.0	5 x Dia	1,000.0	5 x Dia	1,000.0
ZF200S	270.0	3	(76.2)	400.0	-	-	431.0	330.0	86.0	15.0	5 x Dia	1,000.0	5 x Dia	1,000.0

- Notes:**
1. Minimum foam inlet pipe size
  2. Take-out (between-the-flange) dimension
  3. Minimum recommended straight pipe length upstream of inductor
  4. Minimum recommended straight pipe length downstream of inductor from recovery horn

## System Specifications

Part No.	Inductor Size	Minimum Flow Rate Lpm	Maximum Flow Rate Lpm	Minimum Inlet Pressure bar	Maximum Inlet Pressure bar	K-Factor Range
ZF40	DN 40 1 1/2 in.	80	480	4	16	40-120
ZF50	DN 50 2 in.	120	720	4	16	60-180
ZF65	DN 65 2 1/2 in.	240	1,600	4	16	120-400
ZF80	DN 80 3 in.	360	2,000	4	16	180-500
ZF100	DN 100 4 in.	550	3,300	4	16	275-1,000
ZF150	DN 150 6 in.	1,100	6,600	4	16	550-2,000
ZF200	DN 200 8 in.	1,650	9,900	4	16	825-3,000
ZF200S	DN 200 8 in.	2,750	16,500	4	16	1,375-5,000

## Working Range of ZF40

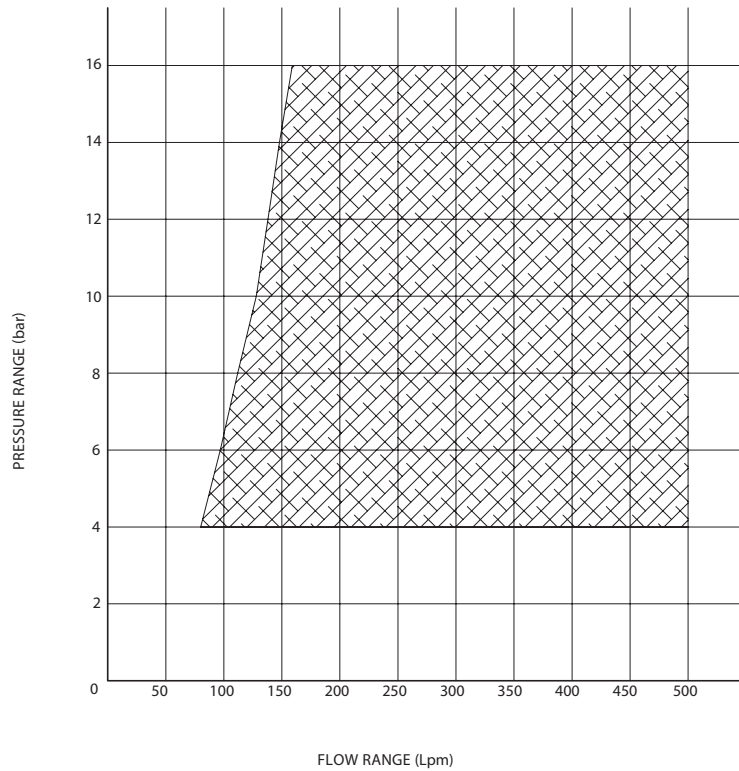

## Working range of ZF50

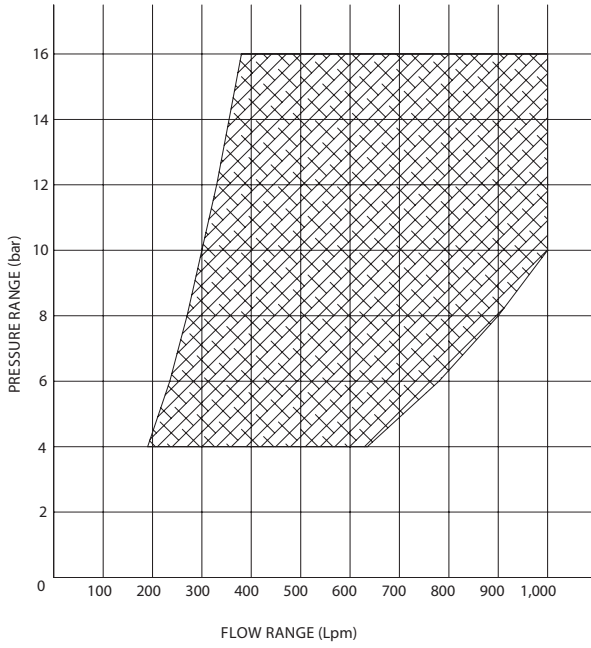

009919

## Working range of ZF80

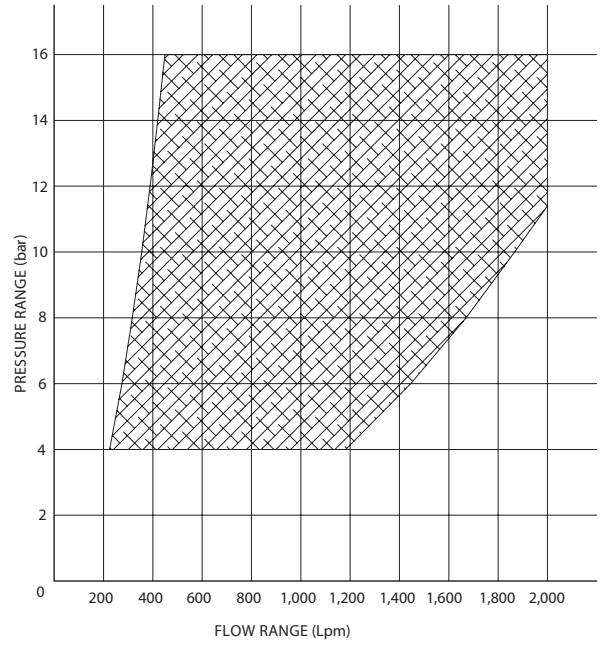

009921

## Working Range of ZF65

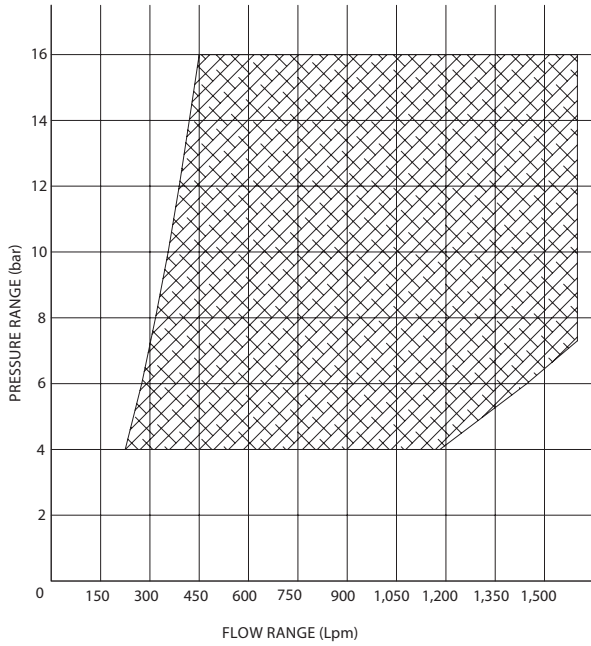

009920

## Working range of ZF100

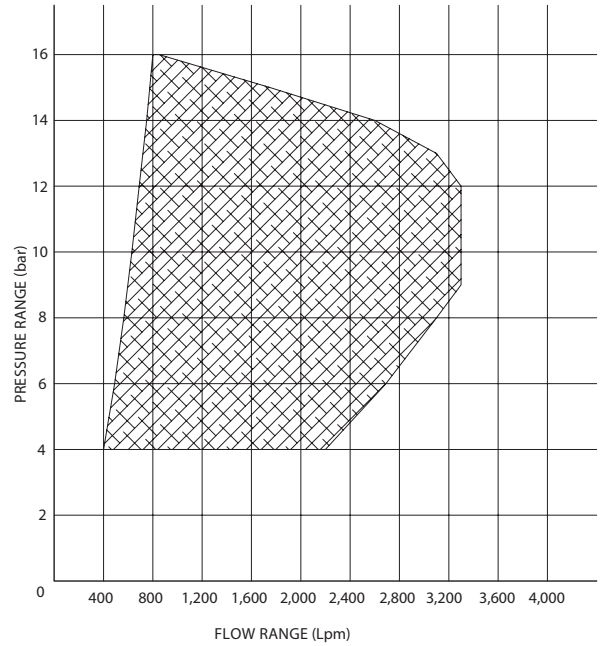

009922

## Working range of ZF150

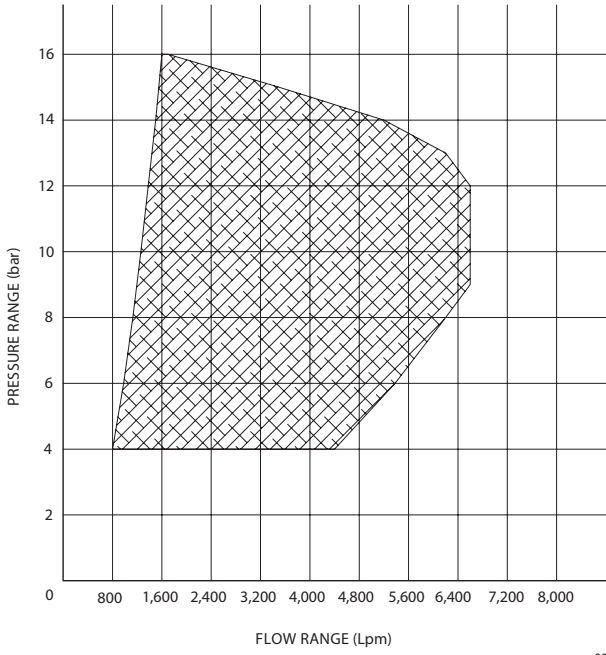

009923

## Working range of ZF200S

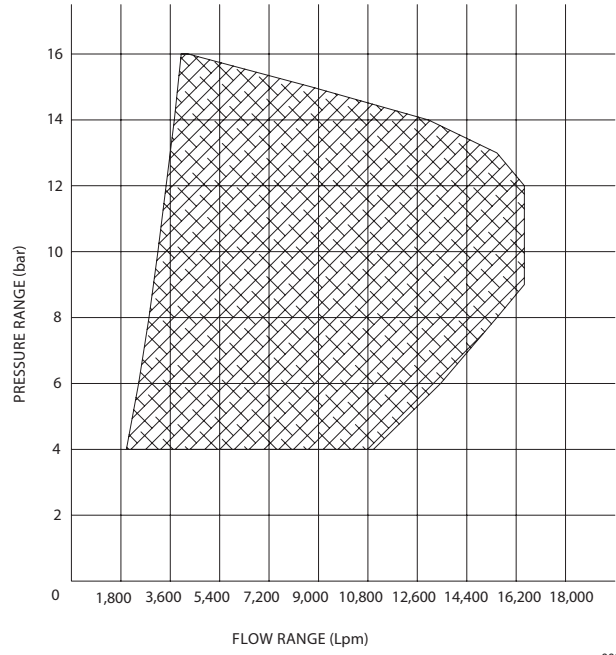

009925

## Working range of ZF200

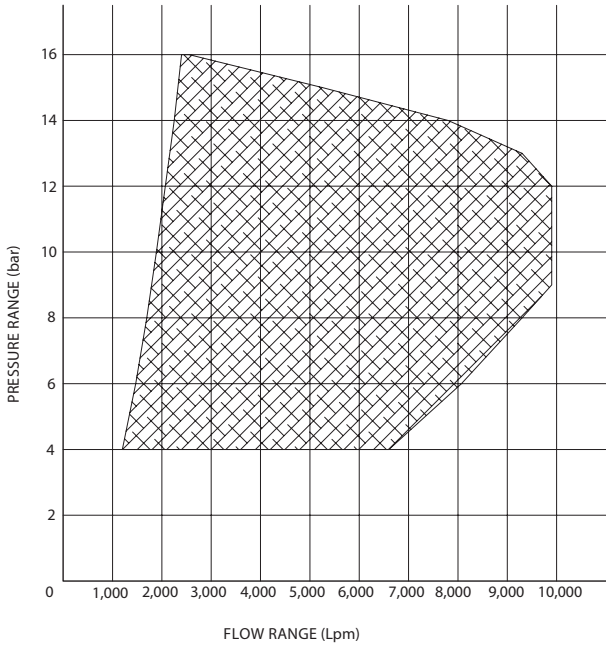

009924

**Note:** The converted values provided in this document are for nominal reference only and do not reflect an actual measurement.

SKUM and the product names listed in this material are marks and/or registered marks. Unauthorized use is strictly prohibited.